

SHOPPERTRON

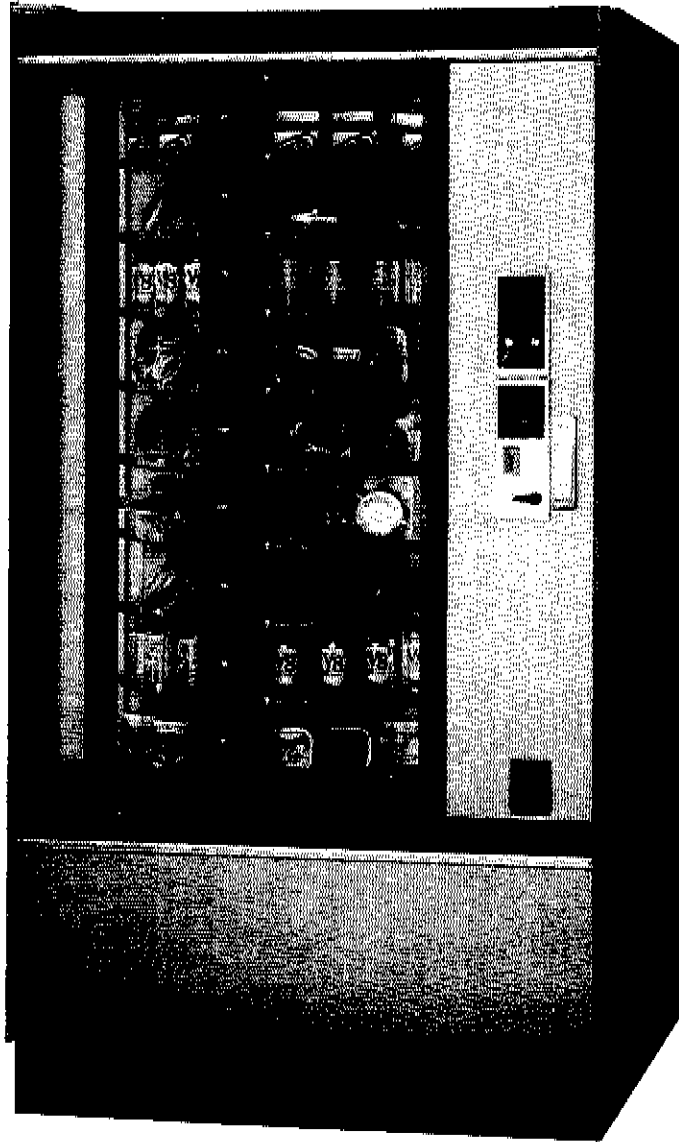

Set-Up Instructions

Copyright ©

430001 REV. L



CRANE- National Vendors

WARRANTY

The Shoppertron™ Merchandiser is warranted for one (1) year against defective parts and workmanship. Any part or parts which are proven to be defective within one (1) year of the date of shipment will be repaired or replaced free of charge when the defective part is returned, with transportation charges prepaid, to the destination designated by the National Vendors Warranty Department.

All refrigeration units and icemakers are warranted on the above basis for a period of one (1) year of the date of shipment.

This warranty applies only to the original purchaser of the Merchandiser and is null and void if the Merchandiser is sold during the period of warranty.

This warranty is also null and void for all electrical components, wiring, or circuits, and/or for all mechanical parts or assemblies damaged as a result of operating the Merchandiser at other than 110-120 volts, 60 Hertz current. The warranty is null and void in event of vandalism, fire, or negligence on the part of the operator.

No warranty is given or implied on incandescent lamps, neon lamps, fluorescent lamps, ballast, or starters, and other expendable items. No warranty will be given when other manufactured components are installed in National Vendors Merchandisers.

Further, National Vendors is not responsible for any cost of service rendered, or repairs made on merchandiser or parts, at other than National Vendors; or by anyone other than an authorized factory service representative of National Vendors; unless authorization to incur such expense has been given in writing by National Vendors prior to incurring such expense.

This warranty is in lieu of all other warranties expressed or implied, including, without limitation, warranties of merchantability, and all other obligation or liabilities on National Vendors part; and National Vendors neither assumes, nor authorizes any person to assume for it, any other obligation or liability in connection with the sale of said equipment or any part thereof.

National Vendors
12955 Enterprise Way
Bridgeton, MO 63044

This machine has been engineered to our own rigid safety and performance standards. It has earned a "Letter of Compliance" from NAMA indicating that it complies with sanitation and health guidelines recommended by the Automatic Merchandising Health-Industry Council (AMHIC) and it conforms with all other NAMA safety recommendations.

To retain the safety and performance built into this machine, it is impor-

tant that installation and maintenance be conducted so as to not alter the construction, or wiring, and that replacement parts are as specified in the Parts Manual. Your investment in this equipment will be protected by using the Set-Up Instructions and Parts Manual in your operation and maintenance work. By following prescribed procedures, machine performance and safety will be preserved.

TABLE OF CONTENTS

SECTION I	- GENERAL INFORMATION AND INSTALLATION	
	Unpacking and Inspecting	1
	Electrical Supply at the Site	1
	Installation of the Merchandiser	3
	Installation of the Coin Mechanism	4
	Installation of the Door Lock	4
	Installation of the Money Box Lock	5
	Health Control	5
	Loading the Merchandiser	6
SECTION II	- PROGRAM OPERATIONS	
	Supervisor Procedures	7
	Configuration Procedures	9e
	Setting the Vend Price	12a
	Setting the Discount 1 & 2 Prices	12b
	Setting Section 3 Access	12c
	Setting Tamper Check	12c
	Setting Mach Load	12d
	Setting the Free Vend	12d
	Making a Test Vend	12d
	Setting the Bill Validator	13
	Testing the Payout Switches	13
	Reading the Internal Temperature	13
	Testing the Health Control	13
	Retrieving Data From Machine Memory (RAM)	13
	Clearing Data From Machine Memory (RAM)	15
	Checking the Diagnostics	16
	Checking the Controller PCB	17b
SECTION III	- ADJUSTMENT, REMOVAL AND REPLACEMENT PROCEDURES	
	Adjusting Product Dividers	18
	Adjusting the Delivery Door Stops	19
	Shelf Assembly Removal and Replacement	19
	Drum Assembly Removal and Replacement	19
	Door Side Trim Removal and Replacement	19
SECTION IV	- ROUTINE SERVICE AND SANITATION	
	General	22
	Daily Service	23
	Daily Sanitation	23
	Weekly Service	23
	Weekly Sanitation	24
	Monthly Service	24
	Monthly Sanitation	24
	Semi-Annual Service	24
	Semi-Annual Sanitation	24
	Cleaning the Coin Validator and Coin Chute ...	24
	Cleaning the Bill Validator	25
SECTION V	- CIRCUITRY	
	Wiring Diagram	26
	Schematic	27

**SHOPPERTRON
SPECIFICATIONS**

SIZE: 72" (182 cm) high, 38" (96 cm) wide, 31.5" (80 cm) deep, 6" legs comply with U.S. Public Health Service and AMHIC of NAMA requirements

WEIGHT: 760 LBS. (347 kg)

POWER REQUIREMENTS: 110-120 volts, 60 Hz, 12 amps

CAPACITY: 9 levels, each level adjustable to 6, 12, 18 or 24 items. Total capacity for 54-216 items

REFRIGERATION SYSTEM: 1/3 h.p compressor, 11.4 oz. (323 g) R-12 charge

OPTIONAL EQUIPMENT

COIN MECHANISM: COINTRON 3000
MARS TRC 6000 (Drop shipped)

BILL VALIDATOR: MAKA NB11B 400 (Bill capacity of 400)

(FACTORY OR FIELD INSTALLED)

Door Locks (Flex-Ace or Van Lock)
Cabinet Base Plate
Money Box Lock

(Specifications subject to change without notice)

SECTION I GENERAL INFORMATION AND INSTALLATION

This Set-Up Instructions provides the information required for proper unpacking, inspection, installation, preparing for vending, adjustment-removal-replacement procedures, routing service and sanitation.

Read the following instructions thoroughly before unpacking, inspecting, or installing the Merchandiser. All references to left and right are as seen when looking at the front of the Merchandiser or the assembly being described. To determine the name and the location of various components, see Figure 1-1.

CAUTION

For Merchandiser installation be sure to follow the sequence as outlined in this section.

Unpacking and Inspecting

- A. Carefully remove the Merchandiser from its shipping carton and place it on a level surface.
- B. Inspect the outside of the Merchandiser for dents, scratches, or any damage resulting from improper handling.
- C. Open the monetary compartment. If the merchandiser is equipped with the optional door lock, the key will be in the coin return receptacle.
- D. Inspect the inside of the cabinet. Observe the location and position of the packing material, should reuse become necessary. Carefully remove all packing material.

NOTE

If any damage was observed while unpacking this Merchandiser, file a claim immediately with the carrier.

E. Instructions for installing the optional Base Plate are included with the Base Plate Assembly when shipped.

F. Inspect the merchandiser electrical connectors and components.

The Location's Electrical Supply

The Shoppertron Merchandiser is equipped with a service cord that terminates in a 3 pin connector. The wall receptacle into which the service cord connector is plugged must be properly polarized and grounded, and supply a constant 120 volts at 60 hertz. The receptacle should be protected by a 15 amp fuse or circuit breaker.

A. Line Voltage

Do not operate the Merchandiser on an electrical supply line over which the voltage may drop below 110-volts during the location's peak power usage time. The warranty of the Merchandiser is null and void when the minimum electrical requirements described here are not met.

B. Wall Receptacle Polarity

Check the polarity of the receptacle with a neon indicator test lamp or a volt-ohmmeter. Measure 120 VAC, per Figure 1-2. If the test lamp does not glow when it is inserted into the receptacle in the position shown, or a voltage is not measured on the meter, have the wall receptacle rewired to conform to the required polarity.

Section I

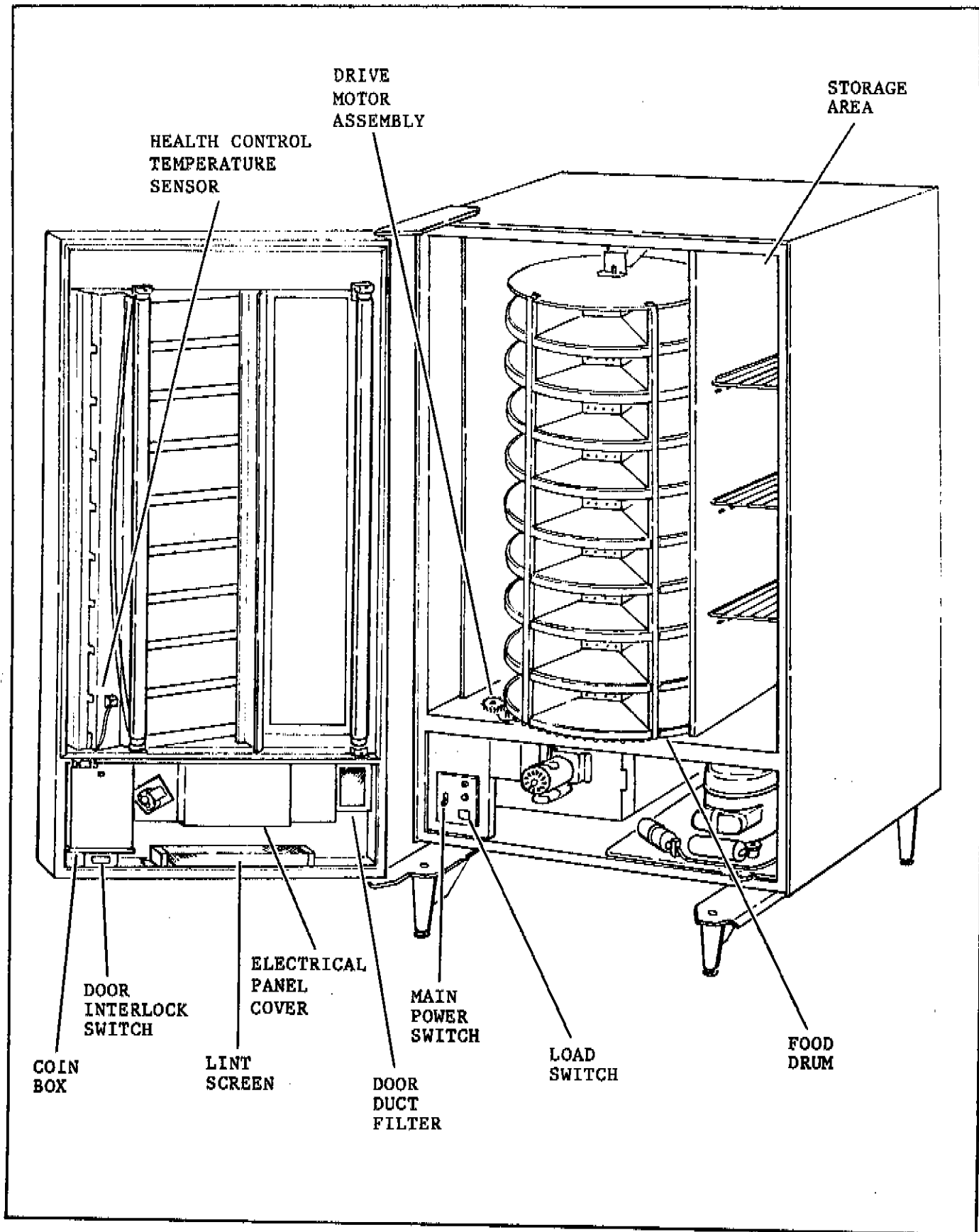

Figure 1-1. Component Locator (1 of 2)

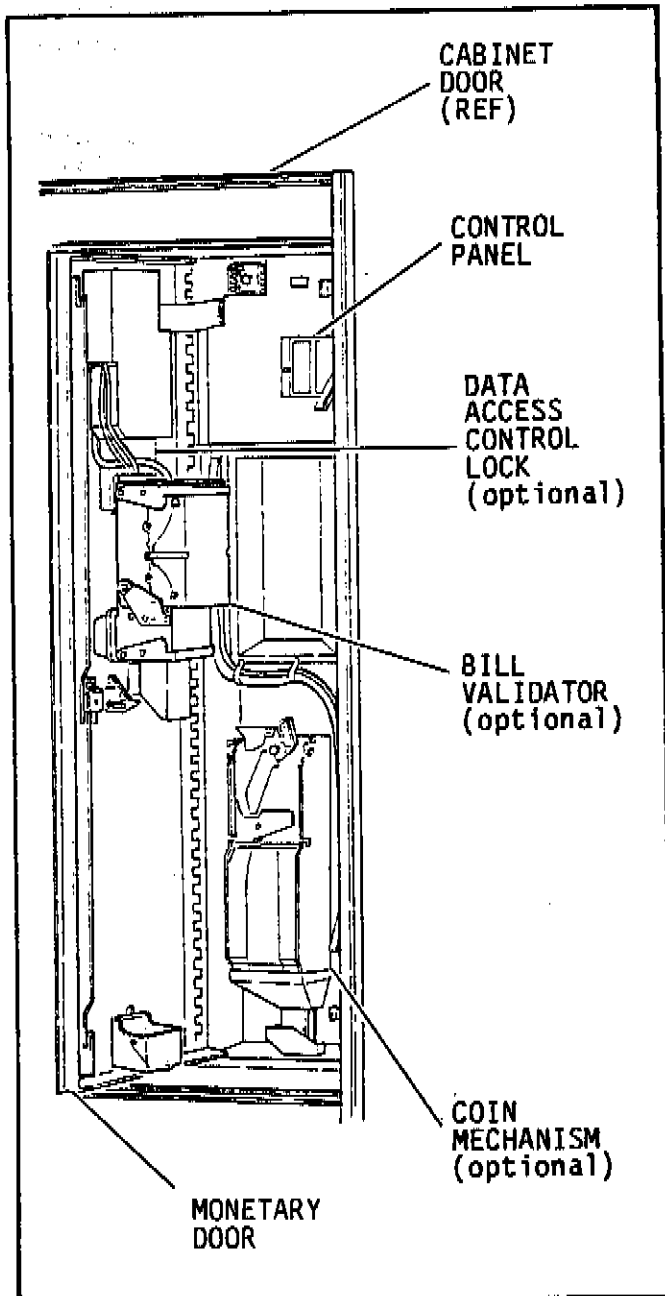

Figure 1-1. Component Locator (2 of 2)

Installation of the Merchandiser

WARNING

This merchandiser is intended for indoor use only.

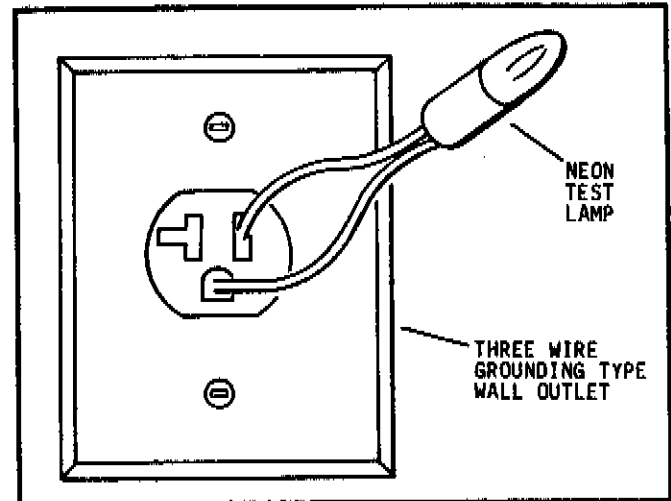

Figure 1-2. Receptacle Grounding Test

CAUTION

For Customer and Serviceman Safety, and to assure proper Merchandiser operation, always be sure the Merchandiser is leveled properly on a flat, solid, stable floor or base foundation.

A. Move the Merchandiser to the desired location. Position the Merchandiser in the desired location at least 6 in. (15 cm) from any wall. Level the cabinet left-to-right and front-to-rear; adjust the leg levelers as required and check with a spirit level. Securely support the merchandiser when tilting the cabinet.

B. For "Bank Style" installations of multiple Merchandisers:

1. Place the first machine in location or at the highest spot if the floor is not level. Extend the leg levelers only as required.

2. Position and level the remaining machines.

Section I

C. Set the main power switch to "OFF".

WARNING

DO NOT plug the Merchandiser service cord connector into a wall receptacle that is improperly polarized and grounded.

D. Connect the Merchandiser service cord to the wall receptacle that has been properly polarized.

E. Move the MAIN Switch to the ON position. Close Cabinet Door. The Display Light will light, the Vent Fan Motor will be energized.

Installation of the Coin Mechanism

To install the coin mechanism, see Figure 1-3 and do the below:

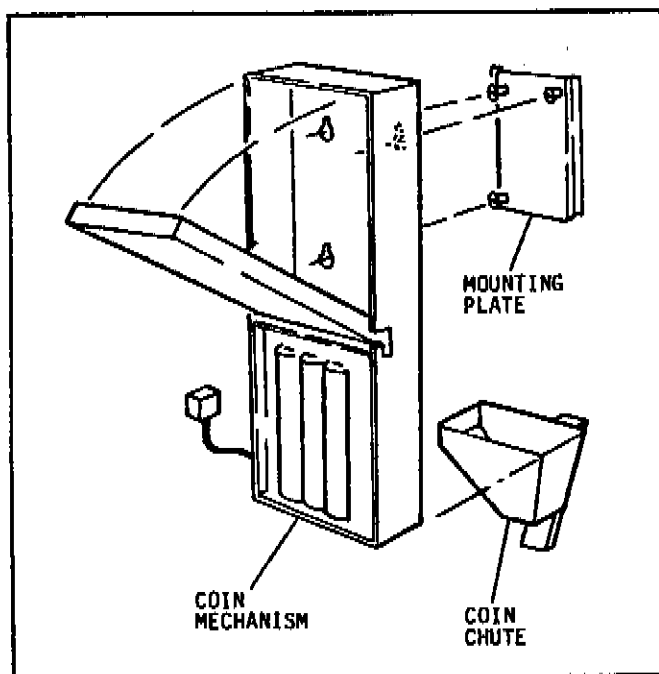

Figure 1-3. Coin Mechanism Installation

CAUTION

Set the main power switch to "OFF" before installing coin mechanism.

A. Refer to instructions provided with the coin mechanism and remove the coin validator assembly.

B. Loosen the coin mechanism mounting screws on the Merchandiser to stand off about 1/8" (0.3 cm).

C. Place the coin mechanism in location with key holes over the three mounting screws.

D. Tighten the mounting screws and reinstall the coin validator assembly.

E. Connect the coin mechanism power-input plug with the power supply connector in the Merchandiser.

NOTE

The quarter tube must have at least four dollars in quarters for the bill validator to work.

F. Fill the respective coin tubes to the desired levels. Insert coins one at a time and make certain that all coins lie flat in the coin tubes.

G. Turn the Main Power Switch to ON.

H. Payout about 6 coins to insure proper loading.

I. Reload the dispensed Coins.

J. Visually check the tubes for shingling of coins.

Installation of the Door Lock

The optional door locks that are available from National Vendors are listed below:

FLEX-ACE (P/N 9992000)
• corresponding key (P/N 9994000)

VAN LOCK (P/N 3112163)
• corresponding key (P/N 3112164)
• kit-lock and key (P/N 3122165)

To install an optional door lock, see Figure 1-4, and do the below:

- A. Remove lock spring.
- B. Depress lock pin and push lock cylinder into lever until pin snaps into place.
- C. Test lock mechanism with key.

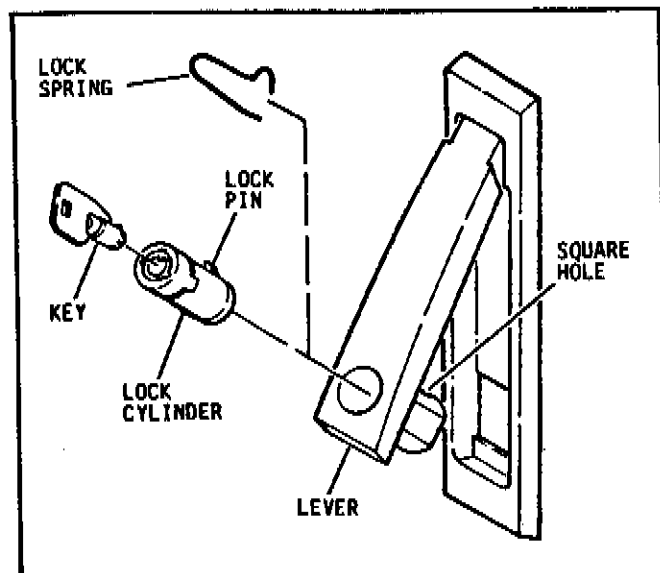

Figure 1-4. Lock Cylinder Installation

Installation of the Money Box Lock

To install the optional money box lock, see Figure 1-5, and do the below:

- A. Remove money box from the merchandiser.
- B. Remove the screw, cam, nut, and washer from the lock assembly.
- C. Insert lock into opening on the money box, and secure with the washer and nut.
- D. Install the cam and secure with the screw.
- E. Place money box back in the merchandiser and test the lock with key(s) provided.

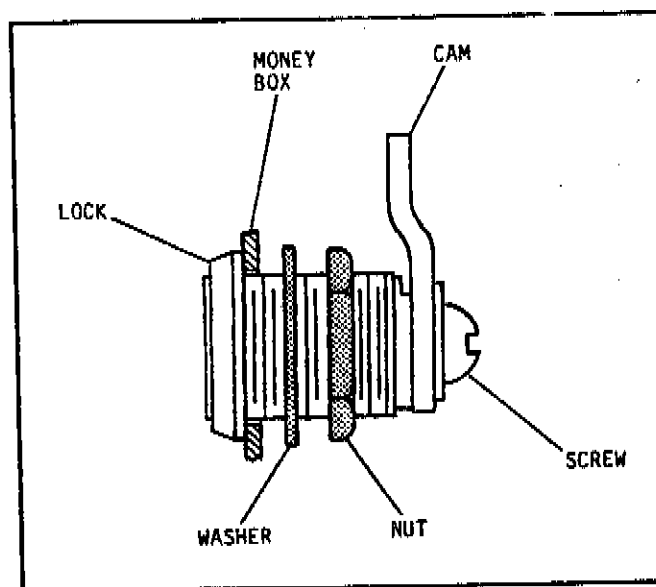

Figure 1-5. Money Box Lock Installation

Health Control

The Shoppertron merchandiser is equipped with an electronic health control. The health control prevents the vending of merchandise under conditions which could have caused the product to become spoiled. A health control is required by most state and local health authorities. The temperature sensor for the health control is located on the inside of the refrigerated cabinet door, see Figure 1-1.

Should the temperature of the refrigerated cabinet not pull down to 45° (7°C) within 30 minutes after the door of the refrigerated cabinet is closed, or if the temperature of the cabinet should rise above 45°F (7°C), the merchandiser will automatically go into an out-of-service mode and food will not be vended. Should this occur, the display will show "Temporary Out Of Service". When the monetary door is opened, the message "Health Off" and the date and time will be displayed. To reset the health control, the refrigerated cabinet door must be opened and closed again.

The out-of-service condition will usually occur at initial set-up.

Section I

therefore, National Vendors recommends that the merchandiser operate with the refrigerated compartment empty until the temperature reaches a level low enough for the health control to be satisfied.

Should it be necessary to test the health control, see Testing the Health Control, Section II.

Loading the Merchandiser

- A. There are two types of loading modes; Full Shop Mode which the entire drum is loaded and Limited Shop Mode where only 1 or 2 zones of the drum are loaded. This mode is usually used on smaller locations. To set the mode, see Setting Machine Configuration Section II.
- B. Adjust the Product Dividers, if applicable. See Adjusting Product Dividers, Section III.
- C. Set new prices, if applicable. See Setting the Vend Price, Section II.
- D. Set discount prices, if applicable. See Setting the Discount 1 and 2 Prices, Section II.

CAUTION

The load switch overrides the Limited Shop mode, enabling the unused Zones(s) of the drum to be loaded.

NOTE

If the drum is loaded with commodities which are too large for the compartments, the drum will not rotate properly.

E. Press and hold the load switch - The drum will rotate.

F. Load the Food Drum.

CAUTION

If Tamper Check is ON or the machine is configured to Prefer Max, the MACH LOAD button must be pressed after closing the refrigeration door. This prevents any compartment doors from being locked out.

G. Close refrigeration door.

H. Press and hold MACH LOADED for two seconds - The Credit Display will show "DRUM FULL".

SECTION II
PROGRAM OPERATIONS

Some set-up, test and maintenance operations are computer controlled. These operations are regulated by the Control Panel switches (see figure 2-1) and the Selection Panel switches (see figure 2-2).

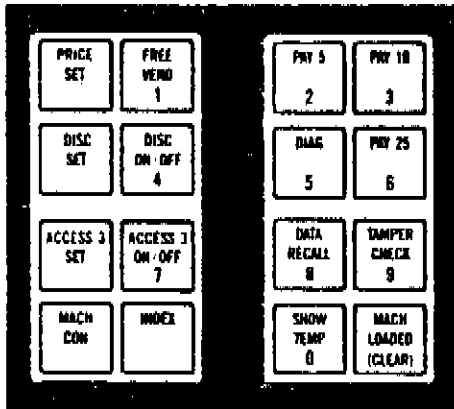

Figure 2-1. Control Panel

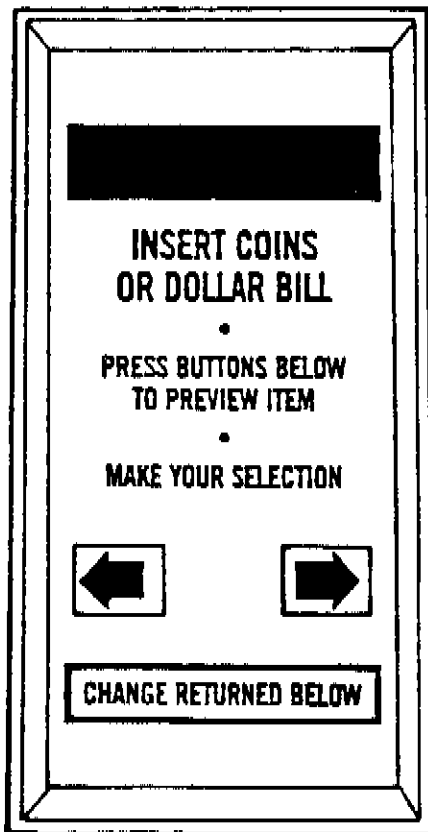

Figure 2-2. Selection Panel

NOTE



All times are shown in 24 hour format. For example 7:30 P.M. is displayed as 1930.

To leave a function, press another function button on the Control Panel or close the monetary door.

Security Control Setting

- . The security control feature lets you control access to stored data and to all of the Functions.
- . Security Control is accomplished by assigning a SUPERVISOR Access Code.
- . Access to the SUPERVISOR mode is possible only for those users who know the SUPERVISOR Access Code.
- . With access to the SUPERVISOR mode, the Supervisor can do any of the following:
 - * LOCK or UNLOCK any of the Functions
 - * SHOW or HIDE any of the Data Categories
 - * Assign a new Supervisor Access Code
- . Users who know this code will have access to all of the Functions and can recall data from all of the Data Categories.
- . Users who do not know this code will only be able to access Functions that are UNLOCKED and Data Categories that are coded for SHOW.

SUPERVISOR PROCEDURE 1

IF YOU WANT TO ...	ENTER THIS KEYSTROKE ...	AND THE DISPLAY INDICATES	COMMENTS
Assign a New ACCESS CODE for the Supervisor	1. Press and Hold INDEX	ENTER CODE	
	2. Enter 0 0 0 0	UNLOCKED	You now have access to all Functions and Data Categories
	3. Press and Hold DIAC/5	SUPERVISOR	You now have access to the Supervisor Function
	4. 	SUPER 0000	
	5. Enter a new 4 digit Access Code	SUPER XXXX	XXXX = the new access code
	6. CONTINUE		Options: 1. Close monetary door less than 5 seconds to retain access to all Functions and Data Categories. 2. Close monetary door more than 5 seconds to leave the Supervisor mode. 3. Repeatedly press  until display shows SUPERVISOR. You can complete another Supervisor Procedure by starting at Step 4 of that procedure.

SUPERVISOR PROCEDURE 2: LOCK or UNLOCK Function Access

STEP	ACTION REQUIRED ...		RESULTS	COMMENTS
1	Press and hold INDEX		Credit Display shows: <u>ENTER CODE</u>	
2	Enter your access code		Credit Display shows: <u>UNLOCKED</u>	LOCKED will be displayed if you enter the wrong Access Code
3	Press and hold DIAG/5		Credit Display shows: <u>SUPERVISOR</u>	You now have access to the Supervisor Function
4	OPTIONS	Press →	Credit Display shows: <u>SUPER xxxx</u>	This allows you to limit data access for all users without codes
		Repeatedly press ← until the desired user is shown	Credit Display shows: <u>USER N xxxx</u>	This allows you to limit data access for users with codes
5	Press the switch for the function you want to Lock or Unlock		Credit Display shows: <u>LOCKED</u> or <u>UNLOCKED</u>	
6	OPTIONS	Press the function switch again to change access	Credit Display shows: <u>LOCKED</u> or <u>UNLOCKED</u>	This allows you to switch between Locked and Unlocked
		Repeat Step 5 for another function		
		Continue		Options: 1. Close monetary door less than 5 seconds retain access to all Functions and Data Categories. 2. Close monetary door for more than 5 seconds to leave the Supervisor Mode. 3. Press → repeatedly until credit display shows SUPERVISOR. You can complete another Supervisor Procedure by starting at Step 4 of that procedure.

SUPERVISOR PROCEDURE 4: ASSIGNING ACCESS CODES FOR USERS OTHER THAN THE SUPERVISOR

STEP	ACTION REQUIRED ...		RESULTS	COMMENTS
1	Press and hold INDEX		Credit Display shows: <u>ENTER CODE</u>	
2	Enter Supervisor Access Code	O P T I O N S	Credit Display shows: <u>UNLOCKED</u>	The correct access code was not entered
			Credit Display shows: <u>LOCKED</u>	
3	Press and hold DIAG/5		Credit Display shows: <u>SUPERVISOR</u>	You now have access to the Supervisor Function
4	Press ←		Credit Display shows: <u>USER 1 xxxx</u>	The supervisor and each of the master users should have unique access codes
5	O P T I O N S	Enter an Access Code for User 1	Credit Display shows: New Code	
		Go to Step 6 and keep the displayed code for User 1		
6	Press ←		Credit Display shows: <u>USER 2 ,xxxx</u>	
7	O P T I O N S	Enter an Access Code for User 2	Credit Display shows: New Code	
		Go to Step 8 and keep the displayed code for User 2		
8	Press ←		Credit Display shows: <u>USER 3 ,xxxx</u>	
9	O P T I O N S	Enter an Access Code for User 3	Credit Display shows: New Code	
		Go to Step 10 and keep the displayed code for User 3		
10	Press ←		Credit Display shows: <u>USER 4 ,xxxx</u>	
11	O P T I O	Enter an Access Code for User 4	Credit Display shows: New Code	
		Go to Step 12 and keep the displayed code		
12	Close the door switch for five seconds			This will exit the Supervisor Mode clear the Supervisor's code from the display
13	Confirm the LOCK/UNLOCK settings for users who do not have codes			
14	Enter the four digit code for each user and confirm LOCK/UNLOCK settings			

- The Data categories will be shown in the following order:

```

VERS
ID          THIS DATA
NR$        WILL ALWAYS BE
SLS$       DISPLAYED FOR
VENDS      AUTHORIZED USERS
*****
FV$        THIS DATA WILL
FV         ONLY BE DISPLAYED
TEST      WHEN IT IS NOT ZERO
CBX$
WIN$
WIN
DS1$
DS2$
$1'S
$5'S
*****
HEALTH     THIS DATA
LAST P.   WILL ALWAYS
LONGEST   BE DISPLAYED
FULL C.   FOR AUTHORIZED
PRICE     USERS
TIME
COLD
WARM
    
```

- Each of these Data categories will be explained under Retrieving Data From Machine Memory later in this section.
- Press the Right Arrow to advance to the next SUPERVISOR function - the credit display will scroll the following message:

24 LETTER CUSTOM MESSAGE

The 24 LETTER CUSTOM MESSAGE procedure is not supported at this time. THIS IS NOT THE SAME AS CUSTOM MSG1 and CUSTOM MSG2 DISCUSSED BELOW.

If you used the Supervisor Access Code, you must close the Monetary Door for less than five seconds if you want to access other functions.

CONFIGURATION PROCEDURES

Press MACH CONF and the Credit Display shows:

CONF XXXX

The CONFIGURE CODE is used to set options for the following categories:

CATEGORY	OPTIONS
TYPE OF MONETARY UNIT	DUMB OR EXEC COIN MECH
	DUMB DEBIT OR GIROVEND DEBIT
APPLICATION	ENGLISH (UK)
	ENGLISH (US/CANADA)
	GERMAN
	FRENCH
SPECIAL USER ACCESS	SUPERVISOR ONLY
	SUPERVISOR & 1 MASTER
	SUPERVISOR & 2 MASTERS
	SUPERVISOR & 3 MASTERS
	SUPERVISOR & 4 MASTERS

- A new code must be programmed whenever any of these options is changed.

SETTING THE CONFIGURATION CODE

STEP	ACTION REQUIRED	RESULT	COMMENTS																																																									
1	Press MACH CON	CONF WXYZ	The current machine configuration code is displayed. (See step 3 for code explanations.) Software versions earlier than "Q" may display an unrecognized value in the YZ position. When this happens, the correct code must be entered.																																																									
2	Press and Hold MACH CON	Two "BEEPS" sound - and - All display segments light	You may now enter a new machine configuration code.																																																									
3	OPTI ONS	Enter a new CONFIGURATION CODE The first three digits of the new code are displayed as you enter them WXY- When you enter the fourth digit (Z), the display goes blank and the standby message is displayed	<table border="1"> <thead> <tr> <th>MONETARY</th> <th>HOME SW</th> <th>VALUE</th> <th>PLACE</th> </tr> </thead> <tbody> <tr> <td rowspan="2">DUMB OR EXEC COIN MECH</td> <td>MECH</td> <td>0</td> <td rowspan="2">W</td> </tr> <tr> <td>MAG</td> <td>8</td> </tr> <tr> <td rowspan="2">DUMB DEBIT OR GIROVEND DEBIT</td> <td>MECH</td> <td>1</td> <td rowspan="2"></td> </tr> <tr> <td>MAG</td> <td>9</td> </tr> <tr> <td colspan="2">APPLICATION</td> <td>VALUE</td> <td>PLACE</td> </tr> <tr> <td colspan="2">ENGLISH (US and CANADA)</td> <td>0</td> <td rowspan="4">X</td> </tr> <tr> <td colspan="2">ENGLISH (UK)</td> <td>1</td> </tr> <tr> <td colspan="2">GERMAN</td> <td>3</td> </tr> <tr> <td colspan="2">FRENCH</td> <td>5</td> </tr> <tr> <td colspan="2">SPECIAL USERS</td> <td>VALUE</td> <td>PLACE</td> </tr> <tr> <td colspan="2">NO CHANGE IN USERS</td> <td>23</td> <td rowspan="5">YZ</td> </tr> <tr> <td colspan="2">SUPERVISOR ONLY</td> <td>00</td> </tr> <tr> <td colspan="2">SUPERVISOR and 1 MASTER USER</td> <td>01</td> </tr> <tr> <td colspan="2">SUPERVISOR and 2 MASTER USERS</td> <td>02</td> </tr> <tr> <td colspan="2">SUPERVISOR and 3 MASTER USERS</td> <td>03</td> </tr> <tr> <td colspan="2">SUPERVISOR and 4 MASTER USERS</td> <td>04</td> <td></td> </tr> </tbody> </table>	MONETARY	HOME SW	VALUE	PLACE	DUMB OR EXEC COIN MECH	MECH	0	W	MAG	8	DUMB DEBIT OR GIROVEND DEBIT	MECH	1		MAG	9	APPLICATION		VALUE	PLACE	ENGLISH (US and CANADA)		0	X	ENGLISH (UK)		1	GERMAN		3	FRENCH		5	SPECIAL USERS		VALUE	PLACE	NO CHANGE IN USERS		23	YZ	SUPERVISOR ONLY		00	SUPERVISOR and 1 MASTER USER		01	SUPERVISOR and 2 MASTER USERS		02	SUPERVISOR and 3 MASTER USERS		03	SUPERVISOR and 4 MASTER USERS		04	
			MONETARY	HOME SW	VALUE	PLACE																																																						
			DUMB OR EXEC COIN MECH	MECH	0	W																																																						
				MAG	8																																																							
			DUMB DEBIT OR GIROVEND DEBIT	MECH	1																																																							
				MAG	9																																																							
			APPLICATION		VALUE	PLACE																																																						
			ENGLISH (US and CANADA)		0	X																																																						
			ENGLISH (UK)		1																																																							
			GERMAN		3																																																							
			FRENCH		5																																																							
			SPECIAL USERS		VALUE	PLACE																																																						
			NO CHANGE IN USERS		23	YZ																																																						
	SUPERVISOR ONLY		00																																																									
SUPERVISOR and 1 MASTER USER		01																																																										
SUPERVISOR and 2 MASTER USERS		02																																																										
SUPERVISOR and 3 MASTER USERS		03																																																										
SUPERVISOR and 4 MASTER USERS		04																																																										
	Go to Step 4 and keep displayed code																																																											
4	Continue		Options: 1. Press MACH CON to remain in the Configure Mode. 2. Enter another function. 3. Close the monetary door.																																																									

Press MACH CONF or the Right Arrow-
the credit display will show:
CUSTOM-MSG 1

- This feature lets you program special messages for your customers.
- You can have two different messages.
- You can set start and stop times as well as days of the week that each message will be displayed.
- When turned ON, the messages will scroll across the credit display when no other information message is present in the display. Information messages include: CREDIT; COINS ONLY; and TEMPORARILY OUT OF SERVICE.
- Upon leaving the factory, the messages will be:

*FIRST 63 LETTER CUSTOM MESSAGE
WITH TRAILING BLANKS*

and

*SECOND 63 LETTER CUSTOM MESSAGE
WITH TRAILING BLANKS*

- If you want to review or change CUSTOM-MSG1, go to the Message Control and Editing Procedure below.
- If you don't want to review or change CUSTOM-MSG1, press MACH CONF or the Right Arrow. The credit display will show:
CUSTOM-MSG2
- If you want to review or change CUSTOM-MSG2, go to the Message Control and Editing Procedure below.
- If you don't want to review or change CUSTOM-MSG2, go to the CHANGE\$1/NO CHANGE Procedure on the next page.

CUSTOM MESSAGE CONTROL AND EDITING

MESSAGE EDITING

- If you want to review or change the Custom Message, press INDEX or the Left Arrow.
 - The scrolling will stop;
 - The beginning of the message will appear;
 - The first character will be flashing.
- If the flashing character is correct, press the Right Arrow and the next character will be the flashing character.
- If you want to change the flashing character, you can enter a letter, a number, a special character or a blank.
 - Repeatedly press the Left Arrow to advance through the following list:

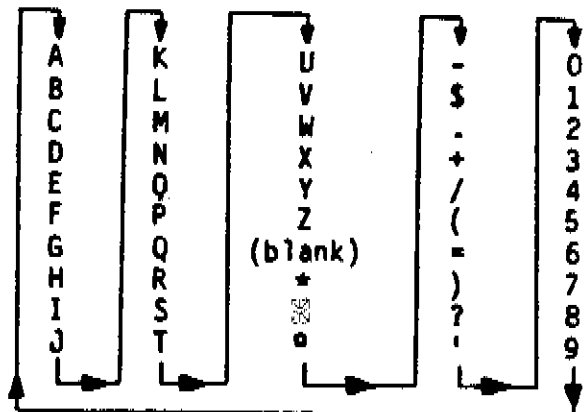

- Press the INDEX key to back through the list.
- You can also press the CLEAR key to enter a blank.
- Numbers can also be entered by using the alternate number keys on the Control Panel.

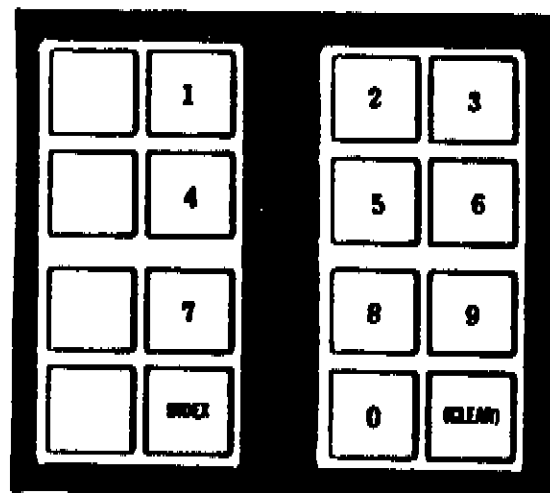

- . Repeat this procedure until you have edited the entire message.
- . The total number of letters, numbers, special characters and blanks must be 63 or less.
- . If your message is less than 63 characters, you must do one of the following:
 - Enter enough blanks at the end of your message to bring the total up to 63.
 - Enter an End of Field Character
- . The message will resume scrolling if you press the Right Arrow when the End of Field Character is flashing or after the 63rd character has been entered.
- . If the scrolling message is correct, go on to Message Control, below.

MESSAGE CONTROL

- . Press MACH CONF or the Right Arrow and the display will indicate:
STRT X HH.MM

NOTE

X = 5 for CUSTOM-MSG1
X = 6 for CUSTOM MSG2

- Use the numeric keys on the Control Panel to enter a new start time if you wish.
- . Press MACH CONF or the Right Arrow and the display will indicate:
STOP X HH.MM
 - Use the numeric keys on the Control Panel to enter a new stop time if you wish.
- . Press MACH CONF or the Right Arrow and the display will indicate:
X SMTWTFS
 - The letters shown are the days the message will be shown.
 - Press the numeric keys on the Control Panel to switch between message shown and message not shown. (1=Sunday thru 7=Saturday)
- . If the message is not to be shown on any days:
 - Press CLEAR if the message is

not to be shown on any days.
The display will indicate:

- MESSAGE ALWAYS OFF
- Set STRT X and STOP X to 00.00.
 - Clear all days of the week.
 - . To show the message at all times:
 - Set STRT X and STOP X with one minute between them. This should be during a low usage time period.
 - Set for showing on all days of the week.

CHANGE\$1/NO CHANGE PROCEDURE

- . Press MACH CONF or the Right Arrow and the credit display will indicate:

CHANGE\$1/NO CHANGE

- CHANGE\$1 permits the return of four quarters by operating the scavenge lever after a \$1 bill has been inserted.
- NO CHANGE requires that a selection be made after a \$1 bill has been inserted. If the selection is inoperative, four quarters will be returned when the scavenge lever is activated.
- Press INDEX to switch between these two options.

DECLINE \$\$/NO DECLINE PROCEDURE

- . Press MACH CONF or the Right Arrow and the credit display will indicate:

DECLINE \$\$/NO DECLINE

- DECLINE \$\$ permits the purchase of more than one item after a credit has been established. Operating the scavenge lever will return change.
- NO DECLINE causes change to be returned after a single selection has been made.
- Press INDEX to switch between these two options.

BILL VALIDATOR CONTROL PROCEDURE

STEP	ACTION REQUIRED		RESULT	COMMENTS	
INITIAL CONDITION			DECLINE\$\$/NO DECLINE Option is displayed		
1	Press MACH CONF - or - →		Current Validator Option is displayed	Options: 1. SERIAL DBV 2. PULSE DBV 3. NO VALDTR	
2	Go to Step 7 and keep the displayed validator option				
3	O P T I O N S	Press INDEX to change from PULSE or SERIAL to NO VALDTR option. Then go to Step 7	NO VALDTR		
		Go to Step 4			
4	O P T I O N S	Press INDEX to change from PULSE or NO VALDTR to SERIAL option. Then go to Step 6.	SERIAL DBV		
		Go to Step 5			
5	Press INDEX to change from SERIAL or NO VALDTR to PULSE option. Then go to Step 7		PULSE DBV		
6	Press MACH CONF		Current Bill Acceptance List OK\$.1.2.5.10.20	The denomination is displayed if the bill will be accepted	
7	O P T I O N S	Switch between Accept and Not Accept for any bill you want to change on the list	New Bill List is displayed	PRESS THIS BUTTON	TO CHANGE STATUS OF THIS BILL
		Go to Step 8 and keep the current Bill List		1	\$ 1.00
				2	\$ 2.00
8	Continue			Options: 1. Press MACH CONF to remain in the Configure Mode 2. Enter another function 3. Close monetary door	

TRAY - (1-4) - The tray on every level can be configured for 1 to 4 compartments. The Price Display shows what each level the trays are presently set for. To change the tray configuration, see Adjusting Product Dividers, Section III and do the below:

- a. Press the numeric Keys to enter the desired configuration using 1,2,3 or 4.
- b. Slide the door to the right for each level to be set for that configuration.
- c. Repeat steps a and b until all levels are set.

SHOP ALL/SHOP 1/SHOP 1 + 2 - see Figure 2-4 and press INDEX for desired mode:

- . SHOP ALL - shops entire drum.
- . SHOP 1 - Shops zone 1 only.
- . SHOP 1 + 2 - shops zone 1 + 2 only.

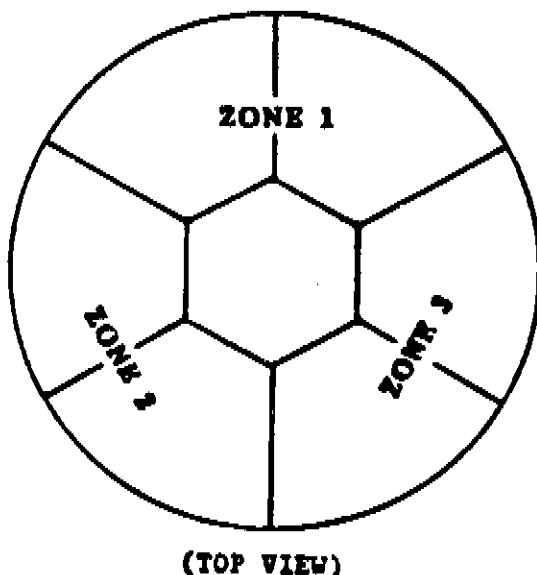

Figure 2-4. Drum Sections

NO PREFER/PREFER 1/PREFER MAX - Press INDEX for desired mode:

- . NO PREFER - Drum centers to present zone after a vend.
- . PREFER 1 - Drum rotates to zone 1 after a vend.
- . PREFER MAX - Drum rotates to the fullest zone after a vend.

NOTE

The active zone of the drum must be fully loaded for "TAMPER ON" and "PREFER MAX" to work properly.

VW DELAY XX - Press the numeric keys to enter the amount of seconds you wish to delay the drum from rotating after a vend is made.

DR DELAY XX - Press the numeric keys to enter the amount of seconds you wish to keep the product door unlocked after a vend.

WIN/NO WINNER - Press INDEX for desired mode. If in Winner mode:

- . Press the numeric keys to enter a number between 50 and 9,999. The winning vend will occur randomly once in that many vends.
- . Winner is now set by tray level. When "WINNER" is enabled, the display at each level will indicate "ON" when that level is designated as a winner sale and will indicate "OFF" when it is not so designated. Move the Vend Doors to switch the associated displays between "ON" and "OFF". All Vends will be counted to determine when a "WINNER" will occur. However, the "WINNER" sale will be delayed when an "OFF" level trips the winner vend total. The next vend from an "ON" level will be the winner.

AUTO ALIGN/NO ALIGN - select "NO ALIGN" and the merchandiser operates as with prior software versions. Select "AUTO ALIGN" and the merchandiser will not unlock a vend door when the compartment is one step out of alignment. It will automatically move the compartment to the correct alignment and allow the customer to try again. When the merchandiser is unable to determine the desired compartment the display will indicate "OFF-LINE, PUSH ARROWS", as would be the case had the "NO ALIGN" option been selected.

TIME XXXX - Press the numeric keys to enter new time.

1. SUNDAY/2. MONDAY/3. TUESDAY/
4. WEDNESDAY/5. THURSDAY/6. FRI-
DAY/7. SATURDAY - Press the numeric
keys (1 thru 7) or INDEX for the
current day.

XX/XX/XX - Press the numeric keys
to enter a new date. The date is
displayed Month/Day/Year numerical-
ly.

Setting the Vend Price

WARNING

Changing prices will not cancel any
previously set discount.

- A. Press PRICE SET on the Control
Panel - the Credit Display will show
"PRC - X SET" and the Price Dis-
plays will show the non-discounted
price.
- B. Press the numeric pads to enter the
new price - the Credit Display will
show the price change.
- C. Slide the product door right to
indicate which price you wish to set
- the Price Display will show the
new price.
- D. If the new price effects all 3
zones, then press INDEX.
- E. Repeat steps B thru D until all
levels are set.
- F. Press Arrow button to move drum to
the next zone.
- G. Repeat steps B thru F until all 3
zones are set.

Setting the Discount 1 and 2 Prices

NOTE

To check the difference between the discount and non-discounted prices, press PRICE SET and DISC alternately.

Press DISC 1 SET on the Control Panel - the Credit Display will show "X.1 = YY 2. = ZZ" (X indicates the zone, YY indicates the % off discount 1 and ZZ indicates the % off discount 2) and the price Display will show the levels for which the discount is in effect.

When YY=99 or ZZ=99 the % off will be 100%.

Press the numeric keys to enter a four digit number indicating the discount percentages for discount 1 & 2 (00 - 99% for each discount).

Repeatedly slide each product door to the right and observe the following on the Price Display each time:

- X.XX the current price
- d1 discount 1 is set
- d2 discount 2 is set
- d1d2 discount 1 and 2 are set

If the discount price effects all 3 zones, then press INDEX.

Repeat steps B thru D for each discount being set.

Press Arrow button to move the drum to the next zone.

Repeat steps B thru F until all discounting is set.

Press DISC SET - the Credit Display will show "START XXXX". Press the numeric keys to enter the stop time.

Press DISC SET again - the Credit Display will show "STOP XXXX". Press the numeric keys to enter the stop time.

Press DISC SET again - the Credit Display will show "SMTWTFS". Press the numeric keys to select the day(s) that the discount is in effect, (1 = Sunday thru 7 = Saturday).

Press DISC SET again and the Credit Display will indicate "STOP 2 XXXX". Press the numeric keys to enter the stop time.

Press DISC SET again and the Credit Display will indicate a variation of "SMTWTFS". The Display will be blank when the merchandiser comes from the factory. Otherwise, the Display will indicate the days during which the discount is currently in effect. The following options are available for setting effective discount days:

Press DISC ON/OFF - two beeps are heard and the third LED on the Controller PCB will light indicating that the discount is on, see Figure 2-5. To terminate discount, press DISC ON/OFF again - 1 beep is heard.

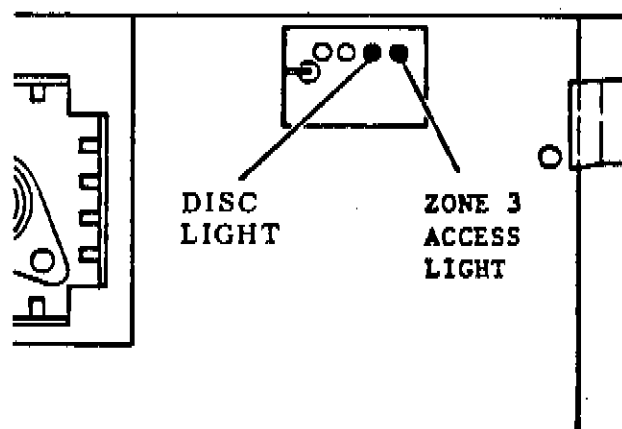

Figure 2-5. Controller PCB

SECTION II

SHOPPERTRON

Zone 3 Access Functions

- . You can ensure that your customers on the second or third shift also have a wide range of foods to select from.
- . When Zone 3 Access is in the ON status, customers can purchase from Zone 3 only during days and times that you have selected.

NOTE

Putting Zone 3 Access in the ON status will override Shop ALL, Shop 1 and Shop 1 & 2.

Setting Zone 3 Access Times:

- A. Press ACCESS 3 SET on the Control Panel - the Credit Display will show STRT 3 XXXX. Press the numeric keys if you wish to enter a new start time. This will be the time when customers will first be able to purchase from Zone 3. This is based on a 24 hour clock - ie 7:30 P.M. is 1930 on the clock.
- B. Press ACCESS 3 SET again - the Credit Display will show STOP 3 XXXX. Press numeric keys if you wish to enter a new stop time. This will be the time when customers will no longer be able to purchase from Zone 3.
- C. Press ACCESS 3 SET again - the Credit Display will show 3 SMTWTFS. These are the days when purchases from ZONE 3 will be controlled. Press the numeric keys to select the days you desire. (1= Sunday thru 7= Saturday).

NOTE

You can set a different access time for a second group of days - i.e. for the weekend.

- D. Press ACCESS 3 SET again - the Credit Display will show STRT 4 XXXX. Enter a new time as done in Step A.
- E. Press ACCESS 3 SET again - the Display will show STOP 4 XXXX. Enter a new time as done in Step B.
- F. Press ACCESS 3 SET again - the Credit Display will show 4 SMTWTFS - Select the days for access as done in Step C.

Activating and Deactivating Zone 3 Access:

- . The status of Zone 3 Access is ON when the fourth LED on the Controller PCB is lit. See Figure 2-5.
- . Press ACCESS 3 ON/OFF on the Control Panel to switch between Access ON and Access OFF.
- . Two beeps will be heard when you switch to the ON status.
- . One beep will be heard when you switch to the OFF status.

Tamper Check Function

- . The Tamper Check feature keeps track of sales by zones. The SHOPPERTRON Controller uses this information to rotate the drum following a sale so the fullest accessible zone is in view. (See preference mode).
 - . If a product is removed and returned to a compartment before the door is closed, it could have been tampered with. The Tamper Check feature will refuse to open that door a second time.
- A. Press TAMPER CHECK on the Control Panel - the Credit Display will show either TAMPER ON or TAMPER OFF.
 - B. Press INDEX on the Control Panel to change the status of TAMPER CHECK.

Press **TAMPER CHECK** again and the credit display will show

ZL XX LEFT

- or -

ZR XX LEFT

where

- . Z is the Zone number
- . L or R is the right or left half of the zone.
- . XX is the number of compartments in that half of the Zone which have not been sold i.e. the doors have not been opened.

Any product in a compartment that indicates as sold may have been tampered with and should be discarded.

Press the Right Arrow or the Left Arrow to rotate the drum until each half of each zone has been checked.

NOTE

TAMPER CHECK will work properly only if the MACHINE LOADED procedure is completed each time the SHOPPERTRON is loaded with product.

Machine Loaded Function

Complete this procedure after you have loaded the SHOPPERTRON.

NOTE

The MACHINE LOADED procedure must be completed when PREFER MAX or TAMPER CHECK features are used.

Press and hold MACH LOADED - you will hear one beep - and the credit display will show
LOADING

Continue to hold MACH LOADED - you will hear 2 beeps - and the credit display will show DRUM FULL.

If you do not have any empty compartments, you have completed this procedure.

IMPORTANT

ALL COMPARTMENTS THAT ARE EMPTY AFTER LOADING MUST BE VENDED.

If you do have empty compartments, press **FREE VEND** on the Control Panel. (This applies if you are not already on Free Vend Status.)

Complete a vend sequence for each of the empty compartments.

Press **FREE VEND** on the Control Panel to cancel the Free Vend status.

Setting the Free Vend

To free vend selected items only, set the respective vend prices to zero. To free vend the entire merchandiser, press **FREE VEND** on the Control Panel - two beeps are heard and the Credit Display will flash "NO MONEY REQUIRED". Price settings are not effected by this function. To terminate free vend, press **FREE VEND** again - one beep is heard.

Making a Test Vend

Press **INDEX** on the Control Panel - the Credit Display will show "TEST VEND" indicating a single test vend can be made.

With the refrigeration door closed, any selection can be made without using money. If money is inserted, change will be paid out when credit exceeds the vend price. The price of the selection is then returned in a few seconds.

Setting the Bill Validator

If the merchandiser is equipped with the optional bill validator, see Setting the Machine Configuration, this section.

The total number of dollar bills that have been accepted will be stored in the computer's memory. To retrieve stored data, see Retrieving Data from Machine Memory, this section.

If the changer is a MARS TRC 6000 the "high quarter" switch must be set to the OFF position. The switch is located on the back of the housing portion of the unit (see Figure 2-6).

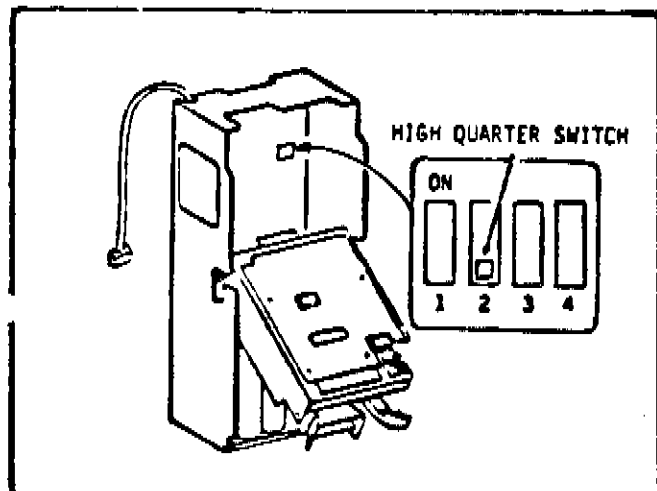

Figure 2-6. MARS TRC 6000 High Quarter Switch

Testing the Payout Switches

Payout switches on the Control Panel function only with the Cointron and Mars coin mechanisms. Press 5¢, 10¢, or 25¢ PAYOUT - nickels, dimes or quarters will be dispensed one at a time.

Reading Internal Temperature

Press SHOW TEMP on Control Panel - the Credit Display will show the time and the temperature of inside the cabinet in degrees Fahrenheit. If refrigeration door was opened within

the last 30 minutes the Credit Display will show the time remaining on the Health Control and the temperature. The internal temperature may also be read by pressing the two rotate buttons together on the Selection Panel.

Testing the Health Control

To test the operation of the electronic Health Control, keep the refrigerated cabinet door closed for a minimum of 30 minutes and then do the following:

- A. Open the Monetary and Refrigerated Cabinet Door and allow 2-3 minutes for the cabinet temperature to rise. When the Health Control sensor temperature has risen above 45° F (7°C) the message "TEMPORARY OUT OF SERVICE" will appear on the Credit Display.
- B. Close the Monetary and Refrigerated Cabinet Door.

NOTE

1. The Health Control automatically resets everytime the refrigerated cabinet door is closed.
2. The internal cabinet temperature displayed by pressing the SHOW TEMP button on the Control Panel. The temperature range displayed is 0° to 255°F.
- C. Should the temperature not pull down below 45°F (7°C) within 30 minutes, the "Temporary Out Of Service" message will be displayed and the merchandiser vend circuit disabled.

Retrieving Data From Machine Memory (RAM)

Sales and vend data for individual zones and levels, as shown in the price displays, can be shown in the credit display by opening the vend door for the level of interest.

Section II

After pressing the DATA RECALL key to enter the Data Retrieval mode, the DATA RECALL key OR the Right Arrow key can be used to scroll forward through the data categories.

The INDEX key OR the Left Arrow key can be used to scroll through the data categories in reverse.

The flash-times for multi-word data messages have been increased to make them easier to read.

NOTE

Press INDEX on the Control Panel to reverse scroll.

Press DATA RECALL on the Control Panel and observe the following on the Credit Display after each time its pressed:

VERS XXXXX - the software version number.

ID XXXXX - the machine ID number; press and hold CLEAR until 2 beeps is heard and the Credit Display shows six zero's. Then press six numeric keys to set the new ID number.

NR \$ XXXX.XX - the total non-resettable sales amount.

SLS \$ XXXX.XX - the total sales amount.

VENDS XXXX - the total number of vends.

FV \$ XXXX.XX - the total sales under free vend.

FV XXXX - the total number of free vends.

TEST XXXX - the total number of test vends (Test Vends are not included in Total Vends).

CBX \$ XXXX.XX - the total amount of cash in the money box.

WIN \$ XXXX.XX - the total sales under winner.

WIN XXXX - the total number of winner's.

DS1 \$ XXXX.XX - the total sales under discount 1.

DS1 XXXX - the total number of vends under discount 1.

DS2 \$ XXXX.XX - the total sales under discount 2.

DS2 XXXX - the total number of vends under discount 2.

NO. \$1 XXXX - the total number of one dollar bills accepted by the bill validator.

NO. \$5 XXXX - the total number of five dollar bills accepted by the bill validator.

HEALTH OFF - the MONTH/DAY and HOURS/MINUTES that the Health Control was off followed by the MAX degrees F reached during this time period.

LAST POWER - the last time the power went off - month/day, hours/minutes and for how long the power was off - FOR day/hours/minutes.

LONG'ST PWR - the longest time the power was off - month/day, hours/minutes and for how long the power was off - FOR day/hours/minutes.

FULL CLEAR, MM/DD HR.MN - the date and time of the last full clear of data using the CLEAR key and the INDEX key together.

PRICE SET - the last time a price was changed - month/day and hours/minutes.

TIME SET - the last time the clock was changed - month/day and hours/minutes.

NOTE

If either door is opened more than once in a ten minute increment, it will only be recorded as one time.

SHOPPERTRON

Section II

COLD 1 XXXM - indicating the duration in minutes and the last time the refrigeration door was opened - month/day and hours/minutes.

COLD 2 XXXM - indicating the duration in minutes and the second to last time the - the second to last time the refrigeration door was opened - month/day hours/minutes.

COLD 3 XXXM - indicating the duration in minutes and the third to last time the refrigeration door was opened - month/day and hours/minutes.

COLD 4 XXXM - indicating the duration in minutes the fourth to last time the refrigeration door was opened - month/day and hours/minutes.

WARM 1 XXXM - indicating the duration in minutes the last time the monetary door was opened - month/day and hours/minutes.

WARM 2 XXXM - indicating the duration in minutes the second to last time the monetary door was opened - month/day and hours/minutes.

WARM 3 XXXM - indicating the duration in minutes the third to last time the monetary door was opened - month/day and hours/minutes.

WARM 4 XXXM - indicating the duration in minutes the fourth to last time the monetary door was opened - month/day and hours/minutes.

• Total Sales, Total Vends, Free Vend Sales, Total Free Vends, Winner Sales, Total Winner Vends, Discount 1 and 2 Sales, and Total Discount 1 and 2 Vends are now shown by either level or by price section. These totals will be shown in the Price Displays. The sale and vend totals are initially shown by level. The totals by price section can be displayed in the Price Displays by pressing "1", "2" or "3" on the Control Panel. Pressing "0" will return the displays to totals by level. The total in the main display on the Selection Panel does not change.

- The colon in the Price Display is used as a decimal point for sales totals less than \$100.00. For sales totals of \$100.00 or more, the colon is not used and totals are rounded down to the nearest dollar. The maximum amount displayed will be \$9999.
- The sales and vend totals by level and section are cleared when the main display data is cleared.

Clearing Data From Machine Memory (RAM)

NOTE

If a non-resettable item is attempted to be cleared, the Credit Display will show "CANNOT CLR".

Health Off, Last Power and Long'st Power can only be cleared individually.

- A. To clear a selected item only, press DATA RECALL until you arrive at the item selected. Then press and hold CLEAR until 3 beeps is heard (approx. 3 seconds).
- B. To clear the entire RAM (resettable data), press DATA RECALL until you arrive at any resettable item. Then press CLEAR and INDEX together until 3 beeps is heard (approx. 3 seconds).

NOTE

The resettable data categories include the group starting with SLS \$ XXXX.XX and ending with LONG'ST PWR.

- C. To verify the data was cleared, complete the "Retrieving Data From Machine Memory" procedure in this section.

SECTION II

Checking the Diagnostics

This merchandiser is constantly monitoring itself. If a problem occurs, the Credit Display will show "TEMPORARY OUT OF SERVICE" Faults 2 thru 14 will not allow the unit to accept money or vend until the problem is corrected. When the monetary door is opened, the Credit Display will show one of these faults.

Press DIAG on the Control Panel and observe the following on the Credit Display after each time it is pressed:

1. NO ERRORS - appears only if there are no diagnostic errors.

NOTE

Faults 2 thru 24 only appear if an error is present in the system.

2. STUCK KEYS - more than one key is stuck on the Control Panel and/or the Selection Panel, disabling the keyboard.
3. RAM ERROR - U13 RAM failure.
4. RAMDATA - U13 RAM battery failure.

NOTE

If any version 05AXX software is updated to version 052AC or greater or if the U13 Ram or the main PC Board is replaced it may be necessary to reconfigure the Ram's check bytes and option registers for coin mech and type of home switch. Turn the machine on and press the "MACH CONF" key to enter any configure step. Now press and hold the "MACH CONF" key until two beeps sound and all the displays light. Enter the 4 digit code listed below for the options that are applicable. Turn power off for a few seconds to restart the software and coin mechanism. If Ram data error reoccurs replace U13.

SHOPPERTRON

COIN MECH	HOME SWITCH	ENTER NUMBERS
COINTRON 3000 OR SIMILAR USA/CANADA APPLICATION	MECHANICAL	0,0,2,3
	MAGNETIC	8,0,2,3
MARS EXEC FOR ENGLISH COINS UK APPLICATION	MECHANICAL	0,1,2,3
	MAGNETIC	8,1,2,3
MARS EXEC FOR GERMAN COINS GERMAN APPLICATION	MECHANICAL	0,3,2,3
	MAGNETIC	8,3,2,3

5. ROM ERROR - U14 ROM checksum failure.
6. HEALTH OFF - the month/day and hours/minutes that the Health Control went off.
7. COIN MECH/NO PWR UP - didn't receive a power up message from the coin unit.
8. COIN MECH/NO DATA - communications failure with coin unit.
9. COIN MECH/SENSOR ERR - sensor error message from coin unit.
10. TEMP XXF - temperature sensor failure - displays present temperature.
11. MOTOR ERR/SOLENOID - input failure from switch activated by solenoid.
12. MOTOR ERR/WHEEL - no input from drive motor slotted wheel.
13. CAN'T HOME - motor or home switch failure.
14. MOTOR JAM - drum movement is obstructed. The controller will periodically try to move the drum to learn if the obstruction has been cleared.

NOTE

Faults 15 thru 24 will not disable the merchandiser.

15. MOTOR ERR/DIRECTION - drum rotation in opposite direction of intent.
16. LEFT KEY - left key on Selection Panel is stuck.
17. RIGHT KEY - right key on Selection Panel is stuck.
18. INSIDE KEY - key on the Control Panel is stuck.
19. CHECK DBV - check the bill validator for jams in the bill path.
20. BILL DATA - no reply from serial validator upon request to send message; check J129.
21. STACK FULL - bill validator stacker is full; this disables only the validator.
22. COP OFF - COP is short for Computer Operating Properly. The Controller does not have the optimum protection from noisy line voltages, electrostatic discharges, electrical noise, etc.

TO TURN COP ON

- Turn main power to OFF.
- Remove cover from the Controller.
- Connect a temporary jumper to the Controller circuit board exactly as shown below:

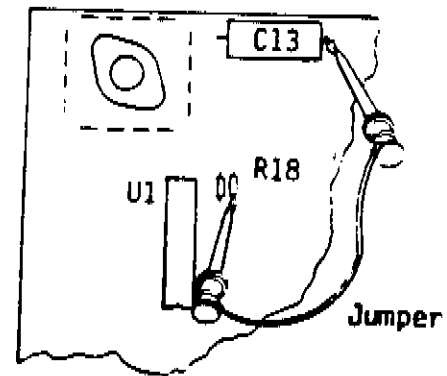

Controller P.C.B.

- Turn main power to ON.
 - Wait for displays to light.
 - Diagnostic message COP OFF still appears.
 - Turn main power to OFF.
 - Turn main power to ON.
 - Diagnostic message COP OFF should no longer appear.
 - Turn main power to OFF.
 - Remove the temporary jumper.
 - Replace the Controller Cover.
 - Turn main power to ON.
23. TAMPER - an attempt has been made to buy from an empty compartment. See setting the Tamper Check, this section.
 24. CHK PRICES - prices may have changed due to an electrical malfunction. The default price is \$12.75. See Setting the Vend Price, this section.
 25. TRAY CONFG - tray configuration program may have changed due to an electrical malfunction. See Setting the Machine Configuration, this section.
 26. CHECK DISC - discount prices may have changed due to an electrical malfunction, setting the discount to 0%. See Setting Discount 1 and 2 prices, this section.
 27. XX.X VOLTS - unregulated voltage for reference only.

SECTION II

SHOPPERTRON

Checking the Controller PCB

Observe the green and first red indicator lights on the controller PCB (see Figure 2-7) when door is open and power is turned on.

- All lights Off indicates power cord is disconnected or no voltage at wall receptacle or fuse under electrical panel cover is open (see Figure 1-1).
- Red Light On - indicates low voltage exists.
- Green Light ON - indicates the controller has power.

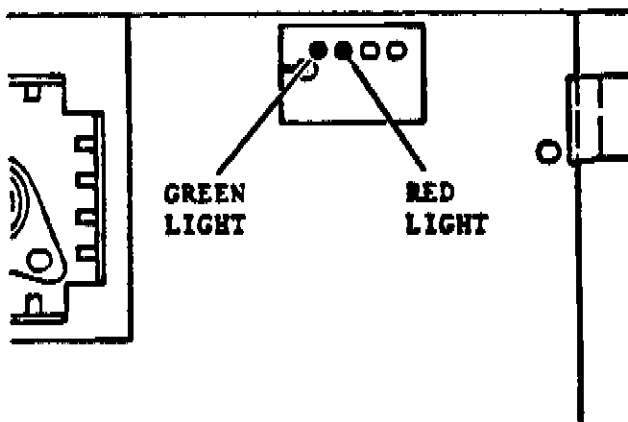

Figure 2-7. Controller PCB

SECTION III ADJUSTMENT, REMOVAL AND REPLACEMENT PROCEDURES

Adjusting the Product Dividers

Product dividers may be adjusted to accommodate various size products. Each level has the capacity range of 6, 12, 18 or 24 products.

NOTE

When adjusting product dividers, make sure that all six trays on each particular level are set the same.

A. To remove the product dividers, see Figure 3-1 and do the below:

1. Firmly grasp the retainer and slide out towards you.

2. Remove the divider.

B. To reinstall the product divider, reverse step A.

C. Change the program operation to match the new tray configuration. See Setting the Machine Configuration, section II.

D. Change delivery door stops to match the new tray configuration for each level. See Adjusting Delivery Door Stops, this section.

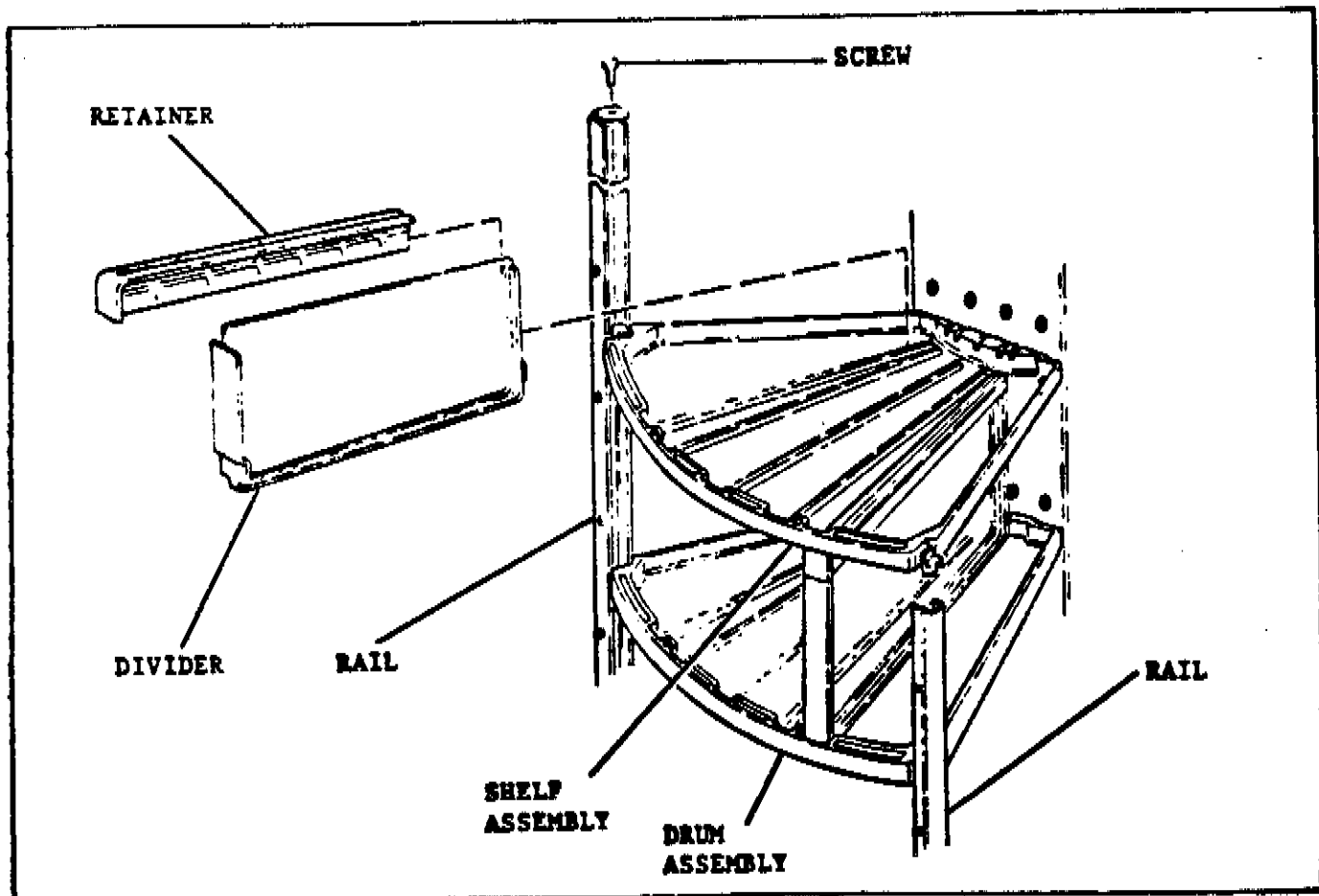

Figure 3-1. Product Dividers and Shelf Assembly Removal and Replacement

Adjusting the Delivery Door Stops

- A. Disconnect temperature sensor from door panel.
- B. Remove the fluorescent light and door panel.
- C. Adjust the door stop(s) as necessary, see figure 3-2.
- D. Reinstall the door panel, fluorescent light and temperature sensor.

Shelf Assembly Removal and Replacement

- A. To remove shelf assembly, see figure 3-1 and do the below:
 1. Rotate drum assembly around until the shelf to be removed is directly in front.
 2. Remove dividers, if applicable. See Adjusting the Product Dividers, this section.
 3. Remove screws and the rails on both sides of the shelf.
 4. Slide out shelf assembly.
- B. To replace shelf assembly, reverse procedure.

Drum Assembly Removal and Replacement**WARNING**

The food drum weight approximately 75 lbs. (34.0 kg). Do Not attempt to

remove or install food drum without help.

- A. To remove drum assembly, see Figure 3-3 and do the below:
 1. Remove any food from drum assembly.
 2. Loosen two screws and remove top bracket assembly.
 3. Lift drum assembly up and out clearing the drive motor assembly.
- B. To replace drum assembly, reverse procedure.

Door Side Trim Removal and Replacement

- A. To remove the door trim, see Figure 3-4 and do the below:
 1. Starting at the top of the door, insert a straight slot screwdriver between the door frame and the door trim and turn a 1/4 turn.
 2. Using a rubber mallet, tap the door trim off as shown.
 3. Move the screwdriver down the door until the door trim is completely removed.
- B. To replace the door trim, align the trim on the door and tap on with a rubber mallet.

Section III

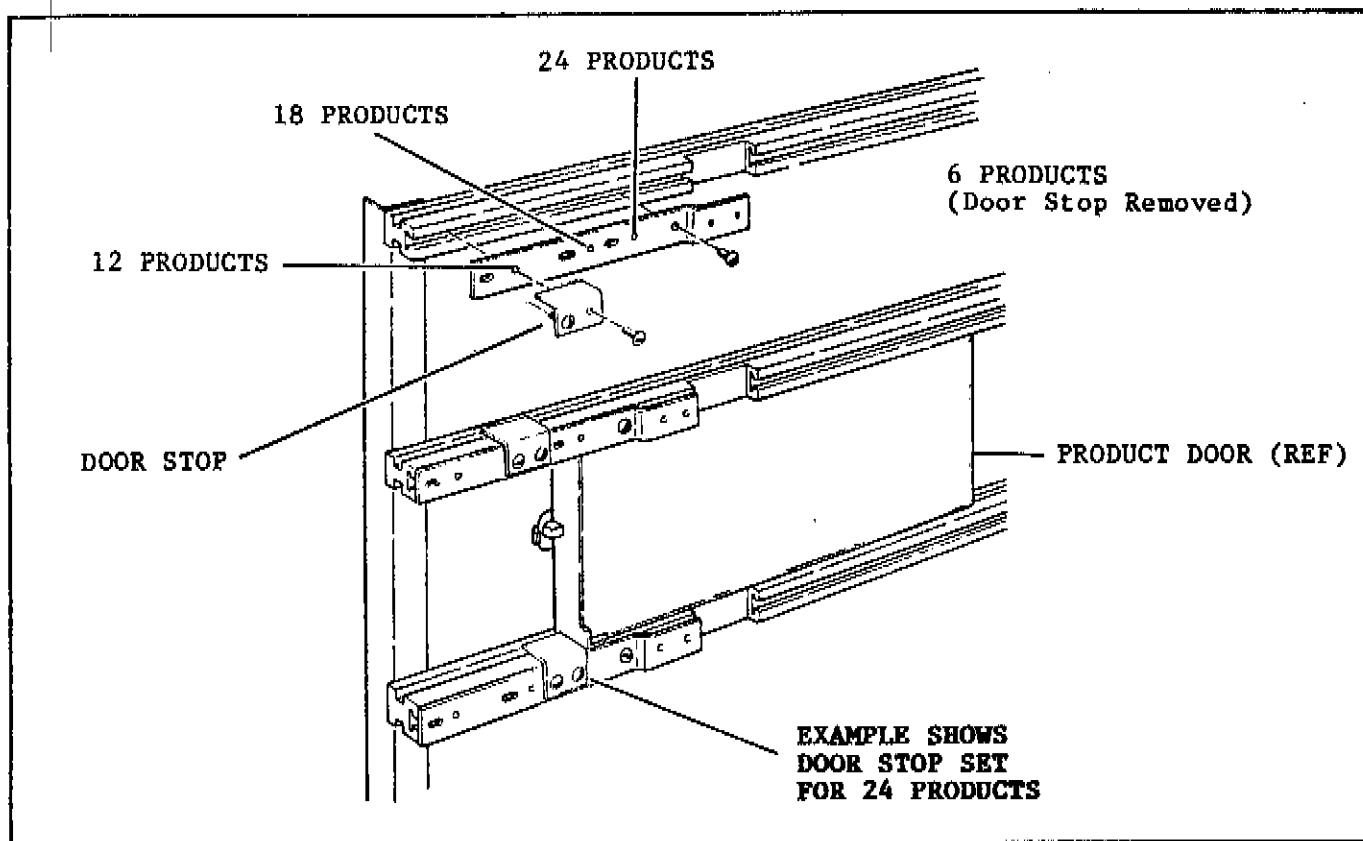

Figure 3-2. Product Door Stop Adjustment

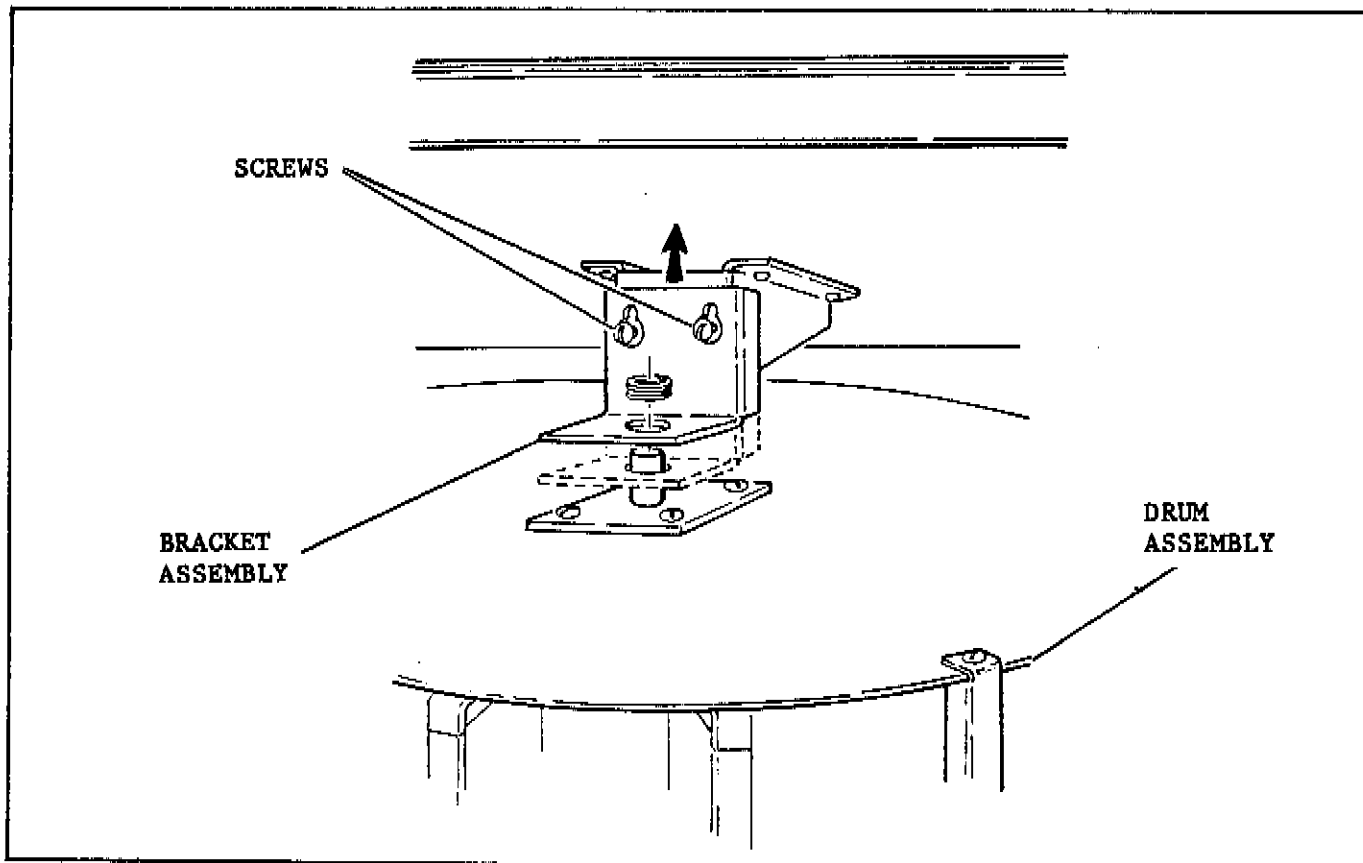

Figure 3-3. Drum Assembly Removal and Replacement

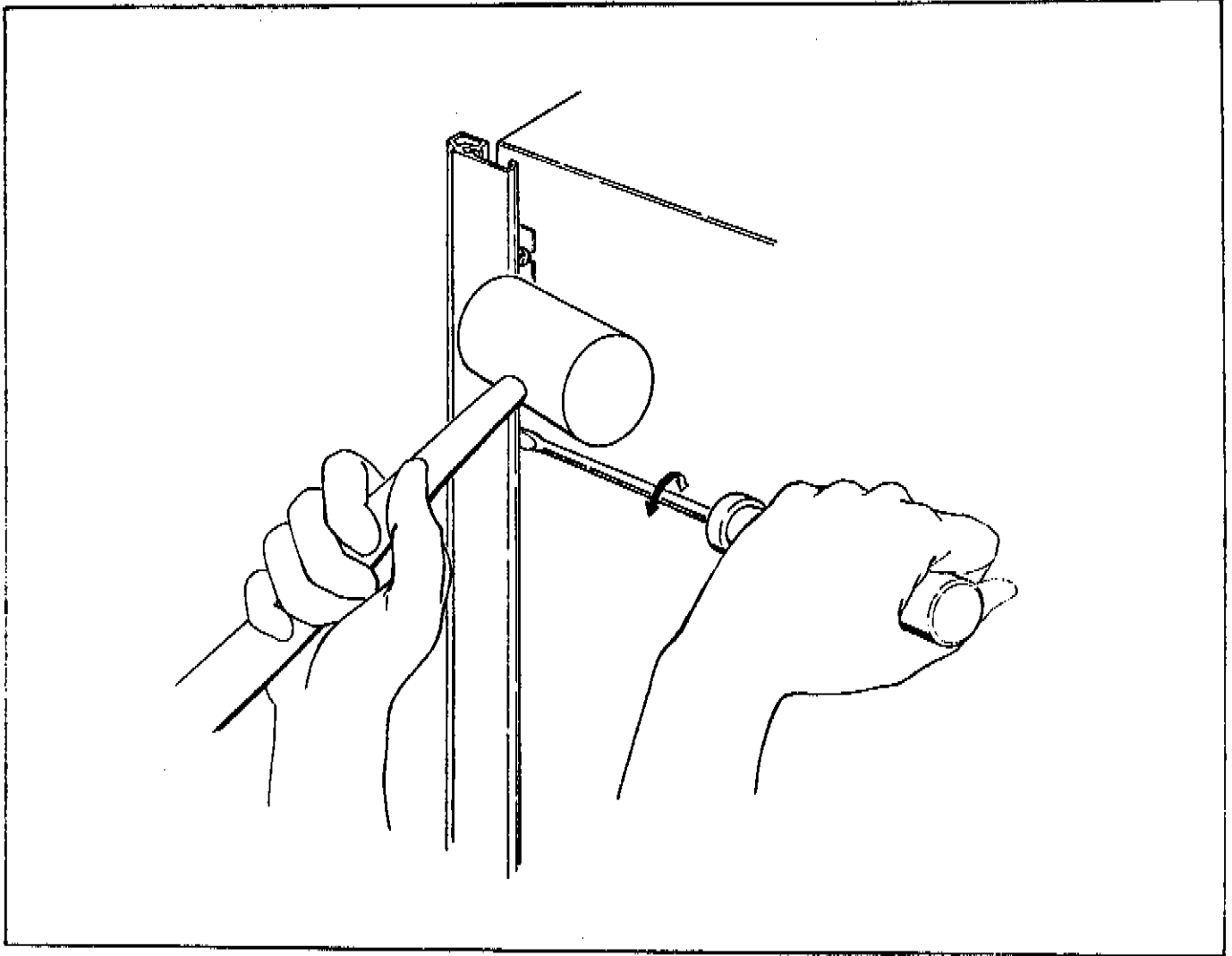

Figure 3-4. Door Side Trim Removal and Replacement

SECTION IV ROUTINE SERVICE AND SANITATION

This section contains information for routine servicing and sanitation of the Shoppertron.

Sanitation is an important phase of Merchandiser operation. The lack of proper service and sanitation can cause Merchandiser malfunction and loss of sales.

The periods and suggested procedures for service and sanitation are daily, weekly, monthly, and semi-annually. These periods and procedures are given as guides only and are not to be construed as absolute or invariable. Local conditions must always be considered. Certain installations require that some or all of the steps under Monthly Service and Sanitation be performed weekly. Each Merchandiser must be maintained individually in accord with its particular requirements. National Vendors, however, stresses "A CLEAN MERCHANDISER IS THE MOST PROFITABLE MERCHANDISER."

Sanitize shall mean effective bactericidal treatment of clean surfaces of equipment and utensils by a process which has been approved by the health authority as being effective in destroying microorganisms, including pathogens.

Sanitizing processes generally accepted by the health authority are as follows:

1. Immersion for at least one-half minute in clean hot water at a temperature not lower than 77°C (170°F)
2. Immersion for a period of at least one minute in a sanitizing solution containing:
 - a. at least 50 ppm of available chlorine at a temperature not lower than 24°C (75°F) or,

- b. at least 12.5 ppm of available iodine in a solution having a pH not higher than 5.0 and a temperature of not lower than 24°C (75°F); or,
- c. any other chemical-sanitizing agent which has been proved to be effective and non-toxic under use conditions, and for which a suitable field test is available.

The following warnings and cautions, are applicable to the service and sanitation procedures given in this section.

WARNING

1. Milk and other foods are perishable products. Follow local health authorities rules and regulations for storage and handling of these items.
2. All loose food particles or spillage whether wet or dry must be removed from the inside and outside of the merchandiser.

CAUTION

1. Do not get electrical connections or electrical components damp or wet.
2. Do not use waxes or lubricants which contain silicone on or in the merchandiser. Silicone or silicone vapors can cause electrical failure.

General

Set the main power switch to "OFF" before cleaning or servicing the merchandiser. Use aerosol spray cleaners or spray waxes only in well-ventilated areas. NEVER use any spray product containing silicone - silicone sprays can coat electrical contacts causing a machine malfunction.

WARNING

Before using any liquid cleaner, unplug the merchandiser power cord or shut off power to the wall receptacle to avoid hazard of electrical shock. Make certain all components are thoroughly dry and properly installed before restoring power.

Refer to the Parts Manual for additional service information and replacement parts. For factory assistance, contact the nearest National Vendors representative.

Contact the Local Health Authorities and obtain their acceptance of the sanitizer you intend to use when cleaning and sanitizing the Merchandiser.

When cleaning and sanitizing the Merchandiser, use CLEAN, DISPOSABLE PAPER WIPER rather than cloths.

Daily Service

- A. Replace burned-out or discolored bulbs.
- B. Replenish coin tubes in the Coin Mechanism.
- C. Empty the bill validator, see figure 4-1.
- D. Test vend the merchandiser. See making a test vend, Section II.
- E. Clean the display glass on the cabinet door.
- F. Check the temperature of the cabinet. See Reading the Internal Temperature, Section III.
- G. Follow the daily sanitation procedures and then reload the merchandiser.

Daily Sanitation

- A. Remove all past-date merchandise from the merchandiser.

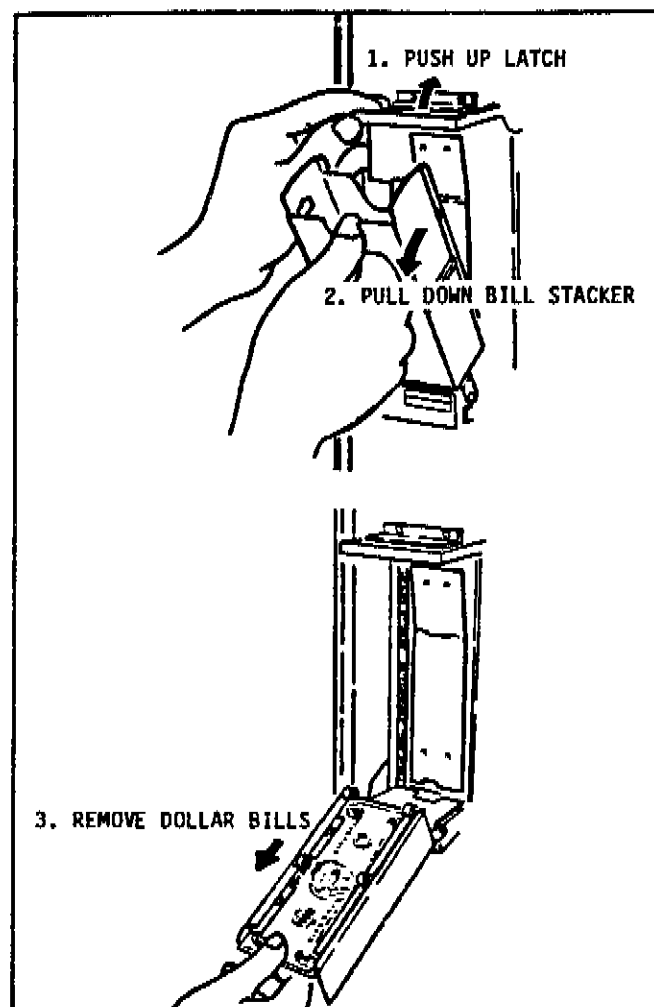

Figure 4-1. Bill validator - Dollar Bill Removal

- B. Check for liquid spillage on the merchandiser modules. If there is spillage, remove the modules shelves and dividers affected and wash and sanitize them with a clean, damp disposable paper wiper or a clean soft-bristle brush. Rinse with clean hot water and dry thoroughly.
- C. Wipe the exterior of the merchandiser with a damp disposable paper wiper and dry thoroughly.
- D. Fill the appropriate columns on the record of cleaning card.

Weekly Service

- A. Follow the Daily Service Instructions.